

TABLETOP SOAP DISPENSER WP192-1



Ø 68 x 456 x 170 mm

chrome-plated brass

- Tabletop soap dispenser in chrome-plated brass.
- Solid body in brass; visible surfaces high-gloss chrome-plated.
- Design height: 208 mm
Outlet height: 198 mm
Projection: 111 mm
- Non-drip soap pump with 500 ml soap container in plastics and pressure valve in brass.
- Also available with 1000 ml containers in plastics.
- 500 ml container in stainless steel as an option for a surcharge.
- Designed for standard liquid soaps.
- Refillable from above by unscrewing the top part.
- Wear parts can be replaced as modules.
- Installation dimensions: Ø 22-26 mm, surface thickness max. 40 mm.
- Mounting: With one counternut.
- Delivery includes fixing material.
- Weight, including single package: 1.6 kg



Suggested text for specifications:

Tabletop soap dispenser in chrome-plated brass for counter mounting. Solid body in brass; visible surfaces high-gloss chrome-plated. Non-drip soap pump with 500 ml soap container in plastics and pressure valve in brass. Designed for standard liquid soaps. Refillable from above by unscrewing the top part. Delivery includes fixing material.

Dimensions: (with container) 65 x 456 x 160 mm

Design height: 208 mm

Outlet height: 198 mm

Projection: 111 mm

Article No. WP192-1

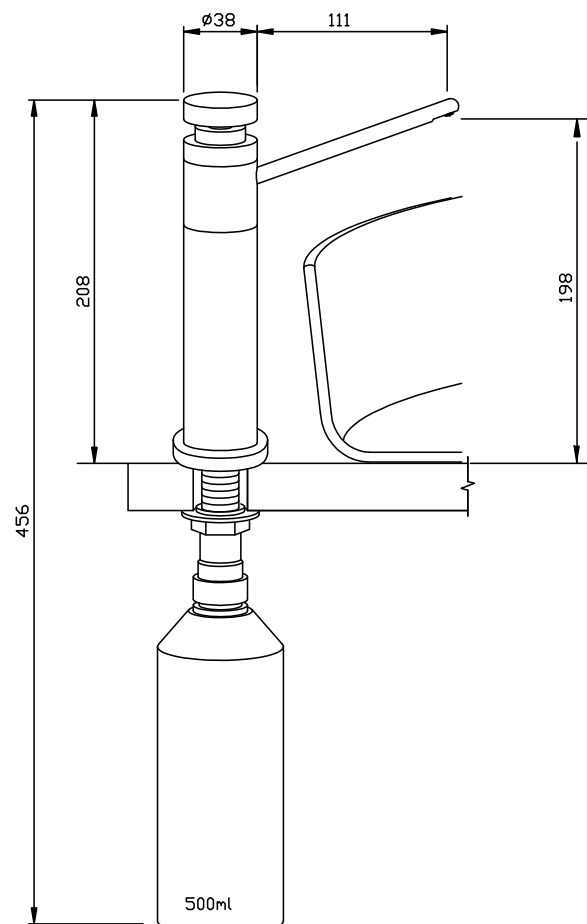

Options	ID No.
Washer / rosette	923 160

Available surface	ID No.
chrome-plated	923 370

Ernst Wagner GmbH & Co. KG

Ernst-Abbe-Straße 21 · D-72770 Reutlingen · Tel.: +49712151539-0 · Fax: -20
info@wagner-ewar.de · www.wagner-ewar.de

WAGNER
EWAR